



# "X57T" Series – (New Space Applications)

5 x 7mm, Hi-Rel Hybrid Microcircuit Crystal Oscillators

5.0V HC/ACMOS/TTL, 3.3V, 2.5V & 1.8V LVHCMOS

500 KHz to 160 MHz

## Features

- 50K Rads(Si) Min. Total Dose Ionization
- Latch-up Immune up to 75 MeV cm<sup>2</sup>/mg LET
- Crystal Mounted at 4 Points
- High Shock & Vibration Design
- Low Profile Surface Mount, 0.079" Max. Height
- 100% Screening per MIL-PRF-55310, Level B plus PIND
- Low Phase Noise
- Hermetically Sealed, Ceramic Package
- Tape & Reel packaging
- Made in USA, ECCN: EAR99

## Applications

- New Space, LEO
- Micro & Nano Satellites
- Commercial Satellites

## Package Specifications & Outline:

- Package: Ceramic 90% Al<sub>2</sub>O<sub>3</sub>
- Seal: Hermetic – Resistance Welded
- Weight: 0.15 Gms Typical, 0.2 Gms Max.
- Thermal Resistance, Junction to Case (θ<sub>JC</sub>): 38 °C / Watt
- Solder Reflow, Temp./Time: 260 °C Max for 10 Seconds Max.
- Pad Finish: 1.27 to 1.9 μm gold over 2.0 to 3.5 μm nickel

Hot Solder Tinning per MIL-PRF-55310 is optional at additional cost.

Contact Xsis Electronics at [xisis@xisis.com](mailto:xisis@xisis.com) for any special requirements.

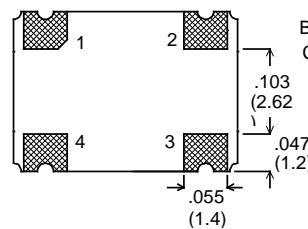
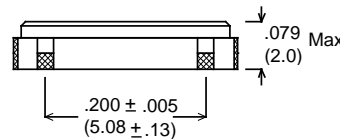
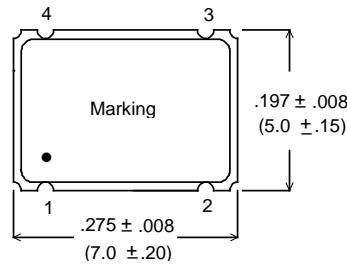

LEAD#	FUNCTION
1	TRISTATE or NC
2	GND/CASE
3	OUTPUT
4	VDD

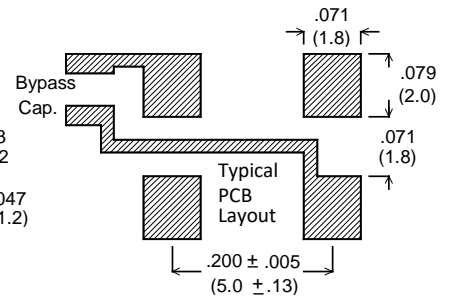

Dimensions: Inches (mm).

An External 0.01uF Bypass Capacitor is required between VDD and GND.

**Tristate Input:** A "Low" level at the input disables the Output into a high impedance state.

Tristate Input has internal pull-up. It can be left floating or connected to Vdd.

## ORDERING INFORMATION ( Please build your part number from options below ) :

P/N EXAMPLE: X57T - L7GM - 24.000 MHz = 3.3V HCACMOS, ± 75 PPM Overall Frequency Accuracy over -55 °C to +125 °C, Tristate Output, 100% Screening, 24.000 MHz

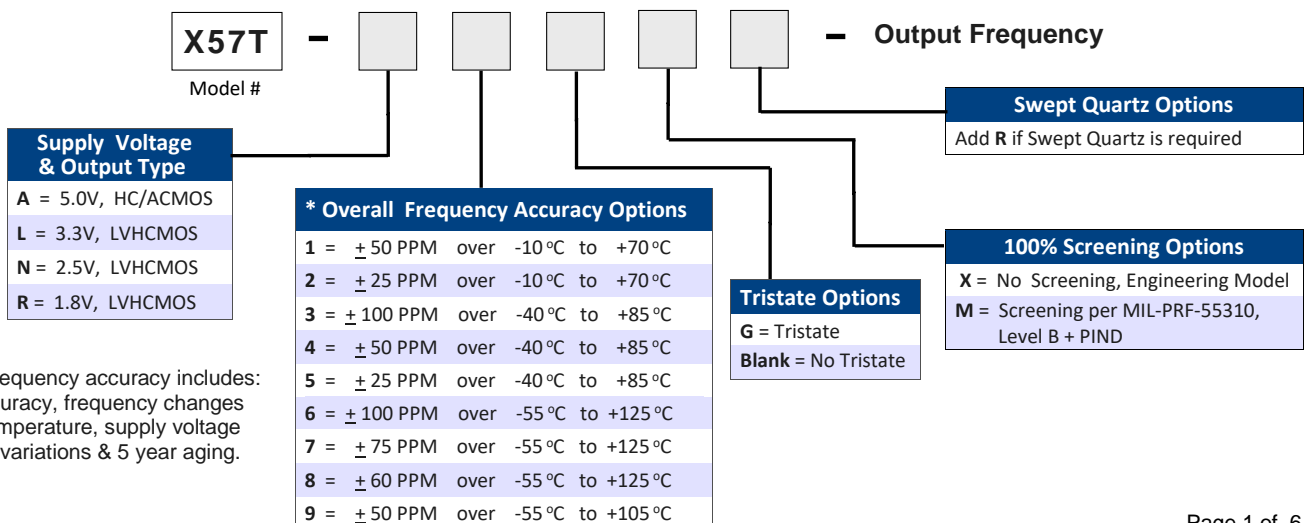

\* Overall frequency accuracy includes: initial accuracy, frequency changes due to temperature, supply voltage and load variations & 5 year aging.



## “X57T” Series – (New Space Applications)

**5 x 7mm, Hi-Rel Hybrid Microcircuit Crystal Oscillators**

**5.0V HC/ACMOS/TTL, 3.3V, 2.5V & 1.8V LVHCMOS**

**500 KHz to 160 MHz**

**Table I - Electrical Specifications, 5V HC/ACMOS/TTL & 3.3V LVHCMOS Oscillators**

Parameter	5V “ Model X57T-A ”	3.3V “ Model X57T-L”
Output Frequency Range	500 KHz to 105 MHz	500 KHz to 160 MHz
Overall Frequency Accuracy ( <i>See Note Below</i> )	See Options in the Ordering Information on Page 1	
Operating Temperature Range	See Options in the Ordering Information on Page 1	
Supply Voltage (Vdd)	+ 5.0V ± 10%	3.3V ± 10%
Input Current (no Load)	500 KHz - 8 MHz 4 mA Max. 8.1 MHz - 32 MHz 10 mA Max. 32.1 MHz - 64 MHz 40 mA Max. 64.1 MHz - 105 MHz 60 mA Max.	500 KHz - 8 MHz 3 mA Max. 8.1 MHz - 32 MHz 6 mA Max. 32.1 MHz - 64 MHz 25 mA Max. 64.1 MHz - 100 MHz 40 mA Max. 100.1 MHz - 130 MHz 50 mA Max. 130.1 MHz - 160 MHz 60 mA Max.
Output Waveform	Square Wave, HC/ACMOS/TTL Compatible	Square Wave, LVHCMOS Compatible
Output Duty Cycle – TTL (at 1.4V Output Level)	60/40% Max.	N/A
Output Duty Cycle – HCMOS (at 50% Level)	45/55%	
Output High Level	0.9 Vdd Min.	0.9 Vdd Min.
Output Low Level	0.1 Vdd Max.	0.1 Vdd Max.
Output Current	± 16 mA Max.	± 8 mA Max.
Output Load	10K // 15 pF or 8TTL loads Max. 50 pF Max. ≤ 50 MHz 30 pF Max. > 50 MHz	10K // 15 pF 30 pF Max. ≤ 50 MHz
Rise & Fall Times (Typical Load) (at 10% to 90% Output Levels)	≤ 40 MHz 6 nS Max. 40 MHz to 75 MHz 3 nS Max. > 75 MHz 2 nS Max.	≤ 40 MHz 6 nS Max. 40 MHz to 75 MHz 3 nS Max. > 75 MHz 2 nS Max.
Tristate Input	≥ 3.5V or Open : Normal Output ≤ 0.8V: High Impedance	≥ 0.7 Vdd or Open : Normal Output ≤ 0.3 Vdd: High Impedance
Start-Up Time	10 mS Max.	10 mS Max.
Phase Jitter (10 KHz - 20 MHz Integrated)	0.3 pS rms Typical	0.3 pS rms Typical
Aging at 70 °C	± 3 PPM Max. first year, ± 2 PPM Max. per year thereafter	
Absolute Maximum Applied Voltage	+ 7 VDC	+ 5 VDC
Storage Temperature	-65 °C to +125 °C	-65 °C to +125 °C

**NOTE: Overall Frequency Accuracy Includes, Initial Accuracy at 25 °C, Frequency changes over Operating Temperature, Aging over 5 years, Frequency changes due to Supply Voltage & Load Variations.**

**For special requirements, please contact Xsis Electronics at [xisis@xisis.com](mailto:xisis@xisis.com) or call us at 913-631-0448.**



# "X57T" Series – (New Space Applications)

5 x 7mm, Hi-Rel Hybrid Microcircuit Crystal Oscillators

5.0V HC/ACMOS/TTL, 3.3V, 2.5V & 1.8V LVHCMOS

500 KHz to 160 MHz

**Table II - Electrical Specifications, 2.5V & 1.8V LVHCMOS Oscillators**

Parameter	2.5V " Model X57T-N "	1.8V " Model X57T-R "
Output Frequency Range	500 KHz to 135 MHz	500 KHz to 100 MHz
Overall Frequency Accuracy (See Note Below)	See Options in the Ordering Information on Page 1	
Operating Temperature Range	See Options in the Ordering Information on Page 1	
Supply Voltage (Vdd)	2.5V $\pm$ 10%	1.8V $\pm$ 10%
Input Current (no Load)	500 KHz-8 MHz 3 mA Max. 8.1 MHz-16 MHz 4 mA Max. 16.1 MHz-32 MHz 8 mA Max. 32.1 MHz-60 MHz 15 mA Max. 60.1 MHz-100 MHz 20 mA Max. 100.1 MHz-135 MHz 30 mA Max.	500 KHz-8 MHz 3 mA Max. 8.1 MHz-16 MHz 4 mA Max. 16.1 MHz-32 MHz 6 mA Max. 32.1 MHz-60 MHz 10 mA Max. 60.1 MHz-85 MHz 20 mA Max. 85.1 MHz-100 MHz 25 mA Max.
Output Waveform	Square Wave, LVHCMOS Compatible	
Output Duty Cycle (at 50% Output Level)	45/55%	
Output High Level	0.9 Vdd Min.	
Output Low Level	0.1 Vdd Max.	
Output Current	$\pm$ 4 mA Max	
Output Load	10K // 15 pF	
Rise & Fall Times ( Typical Load ) ( at 10% to 90% Output Levels )	$\leq$ 40 MHz 6 nS Max. 40 MHz to 75 MHz 3 nS Max. > 75 MHz 2 nS Max.	$\leq$ 40 MHz 6 nS Max. 40 MHz to 75 MHz 3 nS Max. > 75 MHz 2 nS Max.
Tristate Input	$\geq$ 0.7 Vdd or Open : Normal Output $\leq$ 0.3 Vdd: High Impedance	
Start-Up Time	10 mS Max.	
Phase Jitter ( 10 KHz - 20 MHz Integrated )	0.3 pS rms Typical	0.3 pS rms Typical
Aging at 70 °C	$\pm$ 3 PPM Max. first year, $\pm$ 2 PPM Max. per year thereafter	
Absolute Maximum Applied Voltage	+ 4.5 VDC	
Storage Temperature	-65 °C to +125 °C	

**NOTE: Overall Frequency Accuracy Includes, Initial Accuracy at 25 °C, Frequency changes over Operating Temperature, Frequency changes due to Supply Voltage & Load Variations and Aging over 5 years**

**For special requirements, please contact Xsis Electronics at [xisis@xisis.com](mailto:xisis@xisis.com) or call us at 913-631-0448.**



## “X57T” Series – (New Space Applications)

*5 x 7mm, Hi-Rel Hybrid Microcircuit Crystal Oscillators*

*5.0V HC/ACMOS/TTL, 3.3V, 2.5V & 1.8V LVHCMOS*

*500 KHz to 160 MHz*

**Table III - 100% Screening per MIL-PRF-55310 Level B, Including PIND**

Test - Inspection	Test Method – Condition
Internal Visual	MIL-STD-883, Method 2017, Level B
Stabilization Bake ( Prior to Seal ) <sup>1/</sup>	MIL-STD-883, Method 1008, Condition C, ( +150 °C ), 24 hours minimum
Temperature Cycling	MIL-STD-883, Method 1010, Condition B
Constant Acceleration	MIL-STD-883, Method 2001, Condition A, Y <sub>1</sub> axis only ( 5000 G )
Seal ( Fine and Gross Leak )	MIL-PRF-55310, Para. 4.8.2.2.2 ( 1(10) <sup>-8</sup> atm-cc/s Max.)
Particle Impact Noise Detection ( PIND )	MIL-STD-883, Method 2020, Condition A
Pre Burn-in Electrical Tests: Record as applicable	Refer to Table III-a below
Burn-in	+125 °C, Nominal Supply Voltage and Burn-in load, 160 Hours Minimum
Post Burn-in Electrical Tests: Record as applicable	Refer to Table III-a below
External Visual	MIL-STD-883, Method 2009

<sup>1/</sup> Vacuum bake and maintain oscillators in dry nitrogen per MIL-PRF-55310

**Table III-a – Pre & Post Burn-in Electrical Tests**

Test Parameter	MIL-PRF-55310 Method	Pre BI 24 ± 1 °C	Post BI 24 ± 1 °C	Post BI Low Temp	Post BI High Temp
Input Current	4.8.5	✓	✓	✓	✓
Output Frequency	4.8.6	✓	✓	✓	✓
Frequency Vs. Temperature Stability	4.8.10.1		✓	✓	✓
Frequency Vs. Supply Voltage	4.8.14		✓	✓	✓
Output Voltage Levels	4.8.21.3	✓	✓	✓	✓
Output Rise & Fall Times	4.8.22	✓	✓	✓	✓
Output Duty Cycle	4.8.23	✓	✓	✓	✓
Start-up time	4.8.29		✓	✓	✓
Tristate, if applicable	4.8.28		✓	✓	✓

**Quality Conformance Inspection:** Group A per MIL-PRF-55310, Level B

**Following QCI Options are available at additional cost:**

Non-destruct Bond Pull per MIL-STD-883, Method 2023

Radiographic Inspection per MIL-STD-883. Method 2012, Class S

DPA ( Destructive Physical Analysis )

Life Test per MIL-STD-883, Method 105, 1000 Hrs. at +125 °C



# “X57T” Series – (New Space Applications)

5 x 7mm, Hi-Rel Hybrid Microcircuit Crystal Oscillators

5.0V HC/ACMOS/TTL, 3.3V, 2.5V & 1.8V LVHCMOS

500 KHz to 160 MHz

**Packaging:** Tape & Reel, See Page 6

## Thermal Characteristics:

Junction to case Thermal Constant ( $\theta_{JC}$ ): 38 °C / Watt

Junction to Ambient (Device floating in free air) Thermal Constant ( $\theta_{JA}$ ): 135 °C / Watt

**Table IV - Typical Phase Noise (dbc/Hz):**

Output Frequency	10 Hz	100 Hz	1 KHz	10 KHz	100 KHz	1 MHz
10 MHz	- 90	-122	-145	-158	-161	-164
25 MHz	-83	-111	-140	-148	-155	-157
50 MHz	-81	-108	-133	-142	-146	-154
96 MHz	-79	-106	-132	-141	-147	-153
110 MHz	-77	-106	-131	-140	-146	-153

**Table V - Environmental Specifications:**

X57T series oscillators are designed to meet or exceed the Environmental tests specified below. Customized screening and environmental testing are also available to meet your special requirements.

Test	Test Conditions
Vibration	0.06" DA, 30 G peak, 10 - 2000 Hz, MIL-STD-202, Method 204, Cond. G
Shock	5000 G, 0.5 mS, half-Sine, MIL-STD-883, Method 2002, Cond. B modified
Temperature Cycling	MIL-STD-883, Method 1010, Cond. C
Thermal Shock	MIL-STD-202, Method 107, Cond. B
Seal ( Fine and Gross )	MIL-STD-883, Method 1014 Cond. A & C
Burn-in	160 Hours, 125 °C, Nominal Supply Voltage & Load
Frequency Aging	$\pm$ 1.5 PPM Max. first 30 days, $\pm$ 3 PPM Max. first year, $\pm$ 2 PPM Max. per year thereafter
Altitude	MIL-STD-202, Method 105, Cond. C
Constant Acceleration	MIL-STD-883, Method 2001, 5000 G
Moisture Resistance	MIL-STD-202, Method 106, Vibration Sub Cycle Omitted
Solderability	MIL-STD-202, Method 208
Resistance to Soldering Heat	MIL-STD-202, Method 210, Cond B. or C as applicable
Resistance to Solvents	MIL-STD-202, Method 215
Internal Water Vapor Content	MIL-STD-883, Method 1018
ESD Classification	MIL-STD-883, Method 3015, Class 1C, HBM 1000 to 1999
Moisture Sensitivity Level	J-STD-020, MSL=1



# "X57T" Series – (New Space Applications)

5 x 7mm, Hi-Rel Hybrid Microcircuit Crystal Oscillators

5.0V HC/ACMOS/TTL, 3.3V, 2.5V & 1.8V LVHCMOS

500 KHz to 160 MHz

## HCMOS Test Circuit

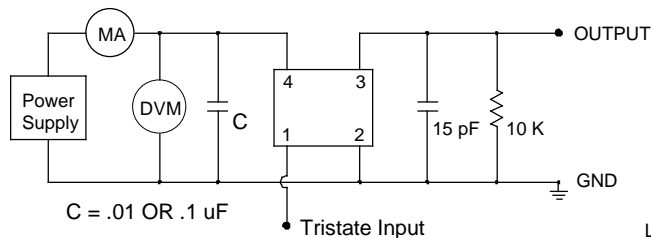

C = .01 OR .1 uF

**Tristate Input** has an internal pull-up resistor. It can be left floating or connected to Vdd.

## HCMOS Output Waveform

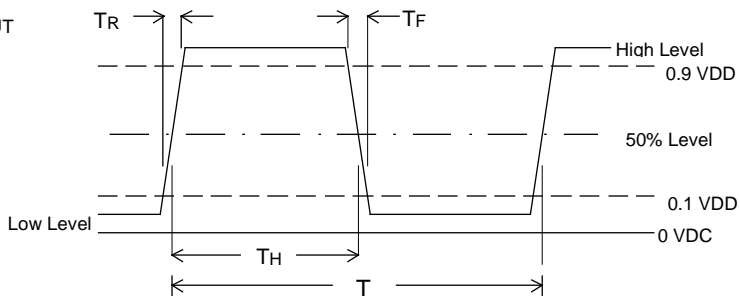

$$\text{Symmetry} = \frac{T_H}{T} \times 100\%$$

## Typical Freq. Stability Vs. Temperature

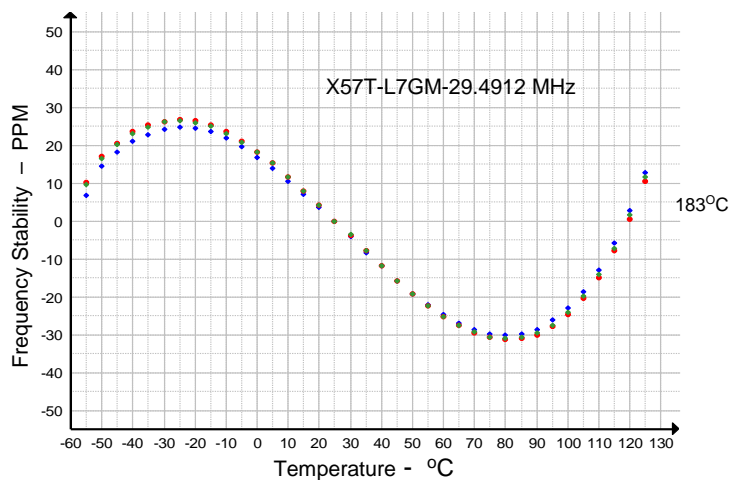

## Tape & Reel Data for X57T parts

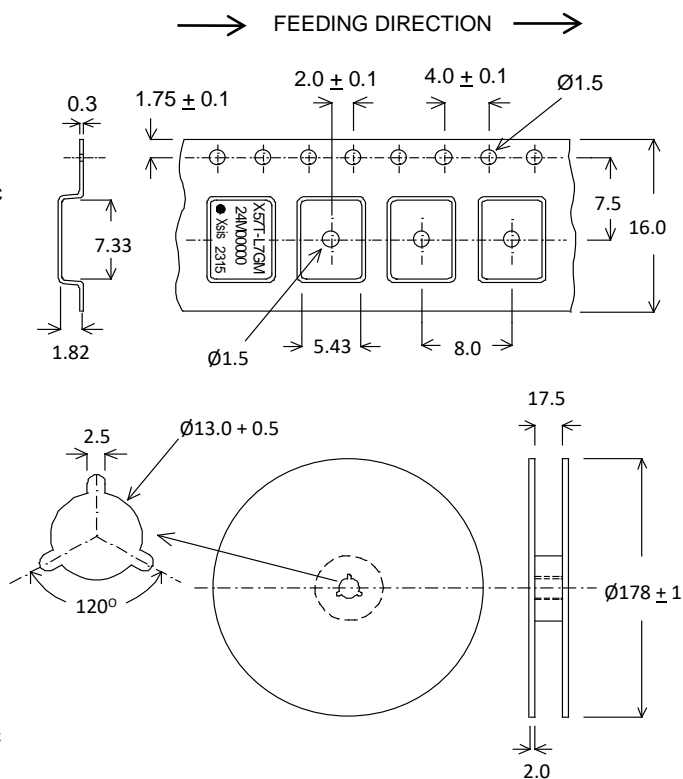

Dimensions are in mm.

## Typical Solder Reflow Profile

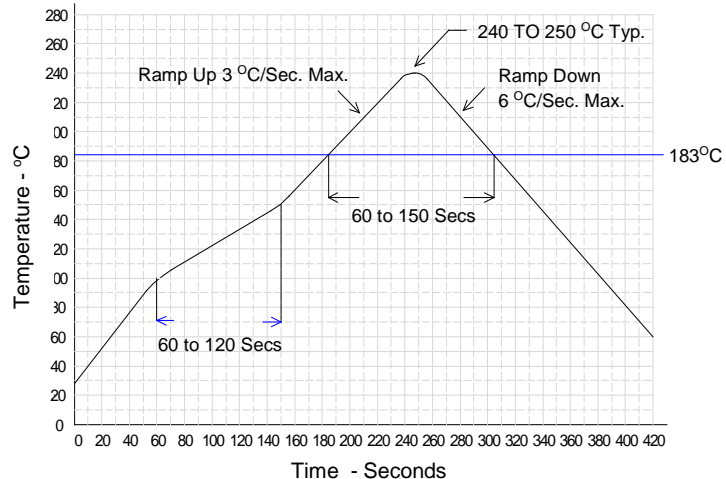

Tape is EIA-481-A Compliant.