



# “XTC52” TCXO Series

## High Reliability Hybrid Microcircuit Crystal Oscillators

3.3V, 2.5V & 1.8V

### Features

- High Shock & Vibration Design, **4 Point Crystal Mount**
- Tristate Output Option
- VC (Freq. Adjust) Option
- Low Profile Surface Mount, 0.160” Max. Height
- 100% Screening per MIL-PRF-883B
- Low Phase Noise
- Hermetically Sealed, Ceramic Package
- Made in USA, ECCN: EAR99

### Applications

- High Shock & Vibration Applications
- Navigation Systems
- Aerospace Instrumentation
- Benign Space Applications
- Gun Launched Munitions
- GPS

### Package Specifications & Outline:

- Package: Ceramic 90% Al<sub>2</sub>O<sub>3</sub>
- Seal: Hermetic – Resistance Welded
- Weight: 0.25 g Typical, 0.3 g Max.
- Thermal Resistance, Junction to Case (θ<sub>JC</sub>): 40°C / Watt
- Solder Reflow, Temp./Time: 260°C Max for 10 Seconds Max.
- Lead Finish: Kovar, 40 to 70 μ inches gold over 100 to 250 μ inches Nickel

Hot Solder Tinning per MIL-PRF-55310 is optional at additional cost.

Contact Xsis Electronics at [xisis@xisis.com](mailto:xisis@xisis.com) for any special requirements.

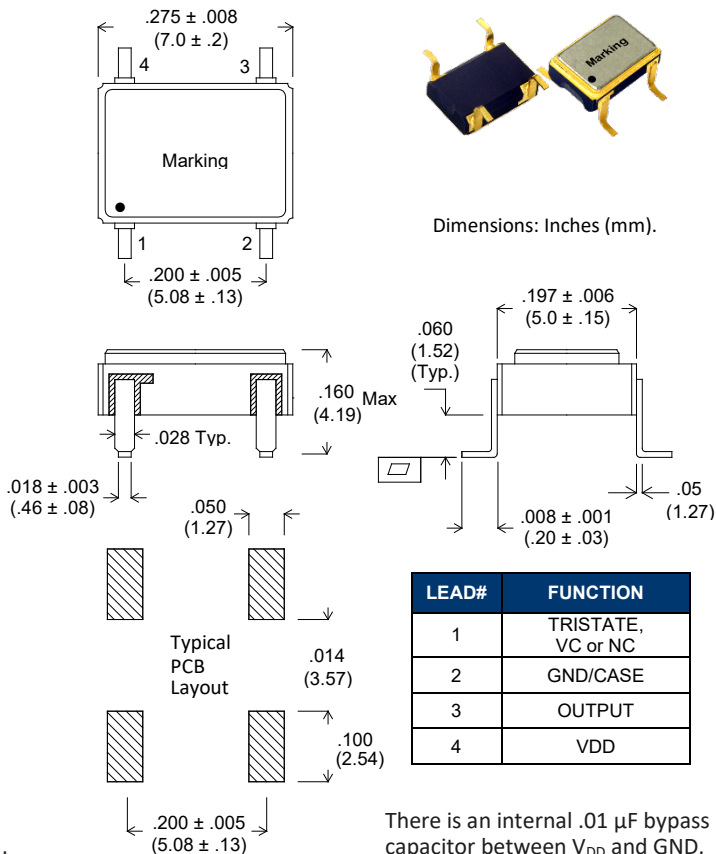

**Tristate Input:** A “Low” level at the input disables the Output into a high impedance state.

Tristate Input has internal pull-up. It can be left floating or connected to VDD.

VC Mode: See Table 2.

## ORDERING INFORMATION ( Please build your part number from options below ) :

P/N EXAMPLE: XTC52R1V - 24.000 MHz = 1.8V, ± 0.5 PPM over -45 °C to +90 °C, VC Mode, 24.000 MHz

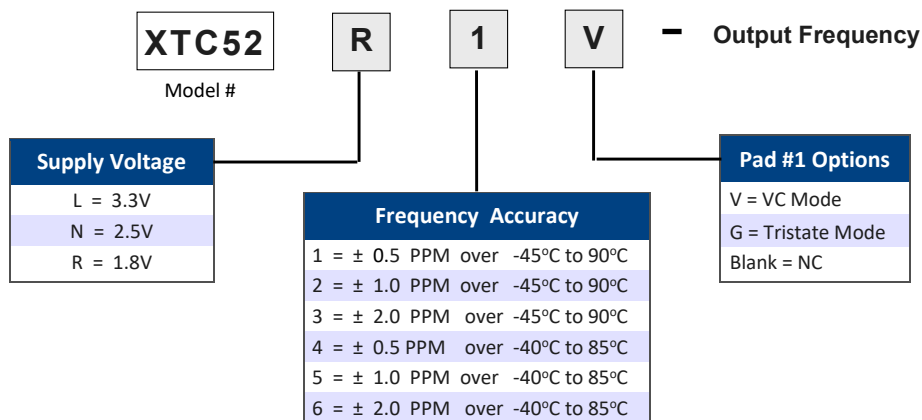



**“XTC52” TCXO Series**  
**High Reliability Hybrid Microcircuit Crystal Oscillators**  
**3.3V, 2.5V & 1.8V**

**Electrical Specifications, 3.3V, 2.5V & 1.8V:**

Parameter	3.3V	2.5V	1.8V
Output Frequency Range	10 MHz to 55 MHz		
Frequency Stability Vs Temperature	See Ordering Information on Page 1		
Operating Temperature Range	See Ordering Information on Page 1		
Supply Voltage (V <sub>DD</sub> )	3.3V ± 5%	2.5V ± 5%	1.8V ± 5%
Input Current (10KΩ // 10 pF load)	3 mA Max.	3 mA Max.	2 mA Max.
Output Waveform	Clipped Sine		
Output Duty Cycle (at 50% Output Level)	55/45%		
Output Amplitude	0.9V <sub>P-P</sub> Min.		
Output Load	10KΩ // 10 pF		
Rise & Fall Times ( Typical Load )	6.5 nS Max. (20% to 80% Output Levels)		
Enable/Disable (When Tristate Mode Specified)	E/D Input ≥ 0.8 V <sub>DD</sub> or Open: Normal Output E/D Input ≤ 0.2 V <sub>DD</sub> : High Impedance		
VC Center Voltage (When VC Mode Specified)	1.2V		0.9V
VC Tuning Range <sup>1/</sup> (When VC Mode Specified)	± 5 PPM Min.		
Start-Up Time	2 mS Max.		
Phase Jitter (10 KHz - 20 MHz Integ.)	0.35 pS rms Typical		
Freq. Stability Vs Supply Voltage	± 0.2 PPM Max. for ± 5% change in Supply Voltage		
Freq. Stability Vs Load Deviation	± 0.3 PPM Max. for 10KΩ ± 10% // 10 pF ± 10%		
Aging at 25 °C	± 1 PPM Max. first year, ± 0.25 PPM Max. per year thereafter		
Absolute Maximum Applied Voltage	+4.5 VDC		
Storage Temperature	-65 °C to +125 °C		

<sup>1/</sup> Voltage on VC not to exceed VDD.

**For special requirements please contact Xsis Electronics at [xisis@xisis.com](mailto:xisis@xisis.com) or call us at 913-631-0448.**



**“XTC52” TCXO Series**  
**High Reliability Hybrid Microcircuit Crystal Oscillators**  
**3.3V, 2.5V & 1.8V**

**Packaging:** Tape & Reel, see Page 4

**Thermal Characteristics:** Junction to case Thermal Coefficient ( $\theta_{JC}$ ): 40 °C / Watt

**Typical Phase Noise (dBc/Hz):**

	10 Hz	100 Hz	1 KHz	10 KHz	100 KHz	1 MHz
10 MHz to 19.99 MHz	-82	-109	-137	-149	-152	-155
20 MHz to 55 MHz	-80	-107	-134	-147	-150	-155

**Environmental Specifications:**

XTC52 series oscillators are designed to meet or exceed the Environmental tests specified below. Customized screening and environmental testing are also available to meet your special requirements.

Test	Test Conditions
Vibration	0.06" DA, 30 G peak, 10 - 2000 Hz, MIL-STD-202, Method 204, Cond. G
Shock	1500 G, 0.5 ms, half-Sine, MIL-STD-883, Method 2002, Cond. B
Temperature Cycling	MIL-STD-883, Method 1010, Cond. C
Thermal Shock	MIL-STD-202, Method 107, Cond. B
Seal ( Fine and Gross )	MIL-STD-883, Method 1014 Cond. A & C
Burn-in	160 Hours, 125 °C, Nominal Supply Voltage & Load
Altitude	MIL-STD-202, Method 105, Cond. C
Constant Acceleration	MIL-STD-883, Method 2001, 5000 G
Moisture Resistance	MIL-STD-202, Method 106, Vibration Sub Cycle Omitted
Solderability	MIL-STD-202, Method 208
Resistance to Soldering Heat	MIL-STD-202, Method 210, Cond B. or C as applicable
Resistance to Solvents	MIL-STD-202, Method 215
Internal Water Vapor Content	MIL-STD-883, Method 1018
ESD Classification	MIL-STD-883, Method 3015, Class 1C, HBM 1000 to 1999
Moisture Sensitivity Level	J-STD-020, MSL=1



# “XTC52” TCXO Series

## High Reliability Hybrid Microcircuit Crystal Oscillators

3.3V, 2.5V & 1.8V

### Test Circuit

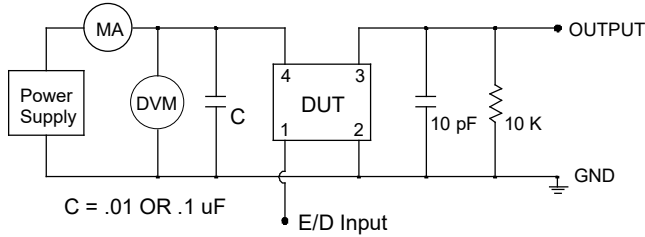

**E/D ( Enable/Disable ) Input** has an internal pull-up resistor. It can be left floating or connected to Vdd.

### Clipped Sine Output Waveform

XTC52R1-24.00000 MHz

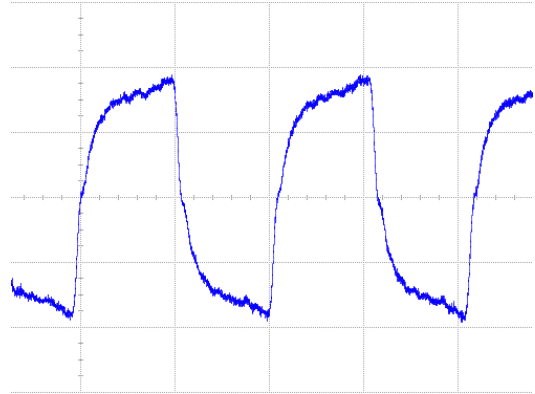

### Typical Freq. Stability Vs. Temperature

XTC52R1-24.00000 MHz

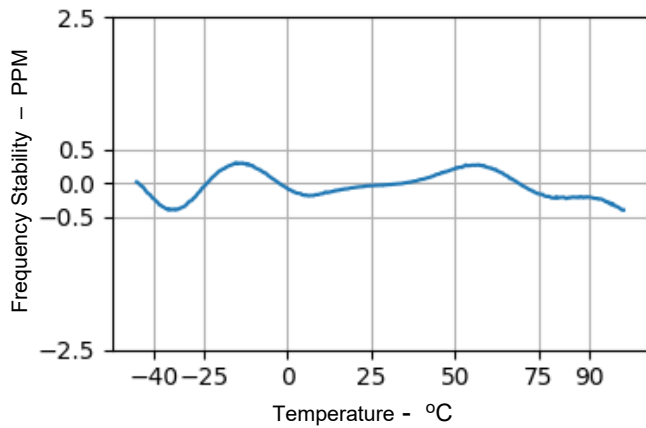

### Tape & Reel Information

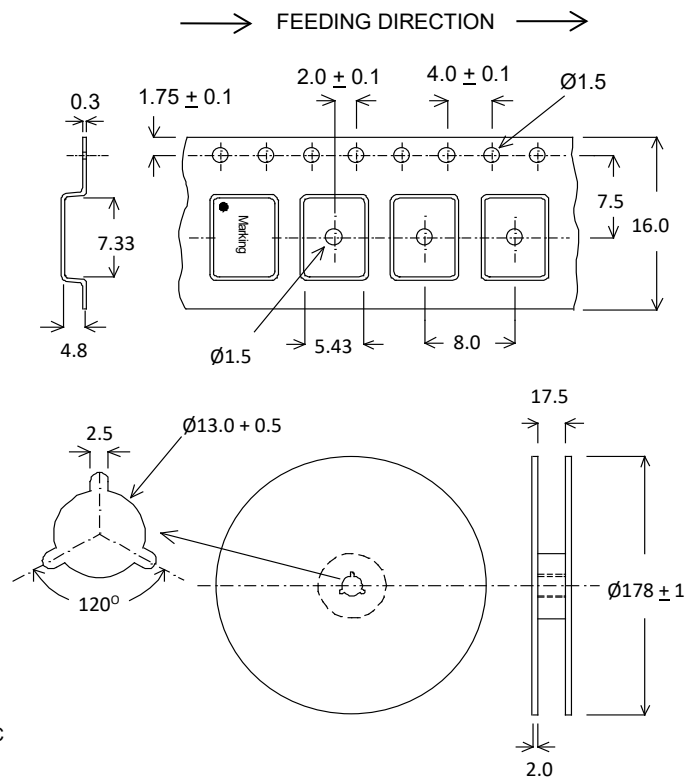

Dimensions are in mm.

### Typical Solder Reflow Profile

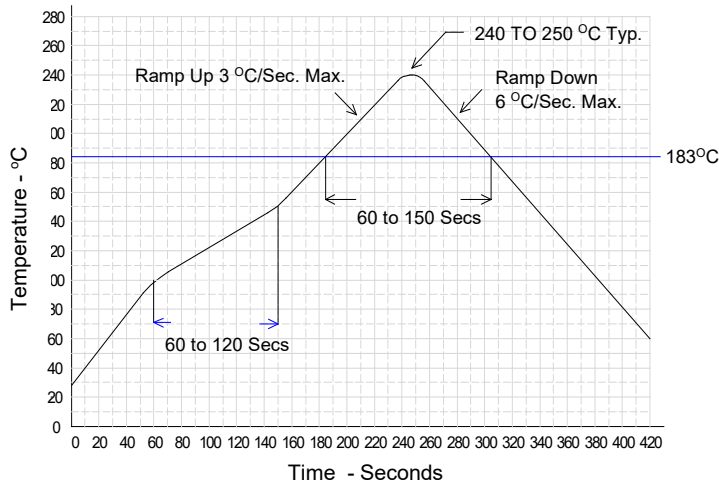

Tape is EIA-481-A Compliant.